

# Development of 3-D divertor solutions for stellarators through coordinated domestic and international research

**Oliver Schmitz<sup>1</sup>**

on behalf of U.S. stellarator collaborators\*

\*J.P. Allain<sup>3</sup>, D.T. Anderson<sup>1</sup>, A.H. Boozer<sup>2</sup>, D. Curreli<sup>3</sup>, J.P. Freidberg<sup>4</sup>, D.A. Gates<sup>5</sup>, J.H. Harris<sup>6</sup>, S.R. Hudson<sup>5</sup>, M. Landreman<sup>7</sup>, J.D. Lore<sup>6</sup>, G.H. Neilson<sup>5</sup>, D.A. Maurer<sup>8</sup>, A. Reiman<sup>5</sup>, D. Ruzic<sup>3</sup>, D.A. Spong<sup>6</sup>, J.N. Talmadge<sup>1</sup>, F.A. Volpe<sup>2</sup>, H. Weitzner<sup>9</sup>, G.A. Wurden<sup>10</sup>, M.C. Zarnstorff<sup>5</sup>

1 – University of Wisconsin

2 – Columbia University

3 – University of Illinois

4 – Massachusetts Institute of Technology

5 – Princeton Plasma Physics Laboratory

6 – Oak Ridge National Laboratory

7 – University of Maryland

8 – Auburn University

9 – New York University

10 – Los Alamos National Laboratory

# An efficient exhaust device is needed to enable steady-state plasmas at high performance

Key elements of integrated magnetic fusion **stellarator** concept:

Steady-state

No disruptions

Energetic particle confinement

**Divertor solution**

**“Divertor solution”** demands testing within an integrated concept due to non-linear coupling between core <-> edge and edge <-> SOL!

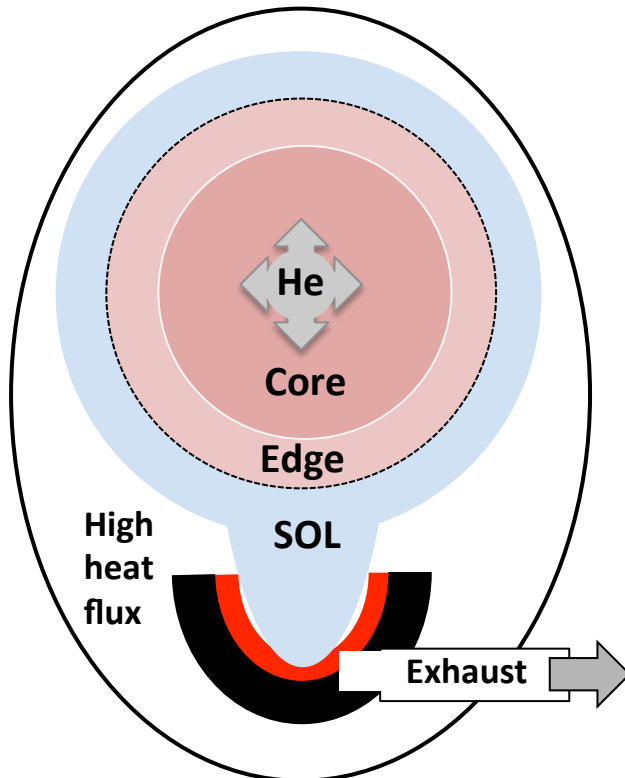

## Core Plasma

Good confinement is required as prerequisite with sufficient transport for helium ash exhaust

Small effects of actual **3-D equilibrium** on 3-D divertor topology

## Edge Plasma

Optimize edge magnetic field topology for **low neoclassical and turbulent losses**

Employ as **radiating mantle** for heat dissipation

## SOL Plasma

Tune for **reduced inward impurity penetration** and well controlled neutral fueling

Optimize topology for **increased power flux channel width**

## Material Interface

Scope with high heat and particle fluxes requiring low erosion, low T retention and overall robustness

**Innovative tests of integrated concepts are required**

# International large scale experiments point to critical challenges for plasma exhaust from high performance devices

## Large Helical Device (LHD)

Test helical divertor performance with stochastic layer as fine actuator interface

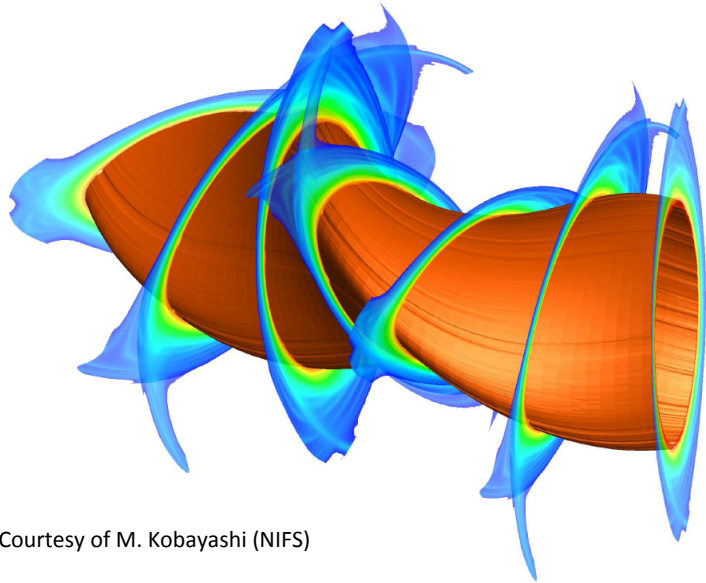

Courtesy of M. Kobayashi (NIFS)

Confinement optimization requires strong equilibrium change

Divertor topology seems feasible for particle and heat exhaust handling

**Challenge: Simultaneous optimization of confinement and divertor**

## Wendelstein 7-X (W7-X)

Test island divertor performance vs. topological stability in optimized stellarator

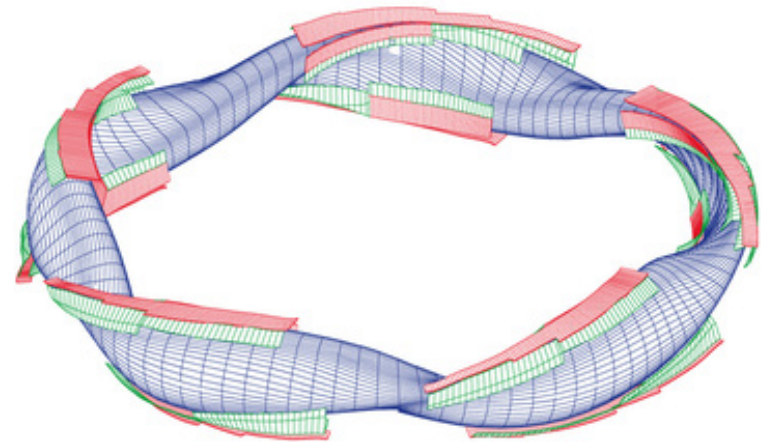

Courtesy of W7-X team

Island divertor topology is very sensitive to not compensated bootstrap current

High heat flux spot to travel across sensitive divertor components during plasma build up

**Efficient divertor operation may require active control (current drive, Trim coils)**

# The proposed initiatives in a nutshell

## Goals



## Means

**Initiative I:** Enhance international collaboration with focus on 3-D divertor physics

**Initiative II:** Well targeted upgrades to existing devices focusing on dedicated challenges from 3-D divertor physics

**Initiative III:** Develop and validate predictive 3-D modeling capability for edge/divertor

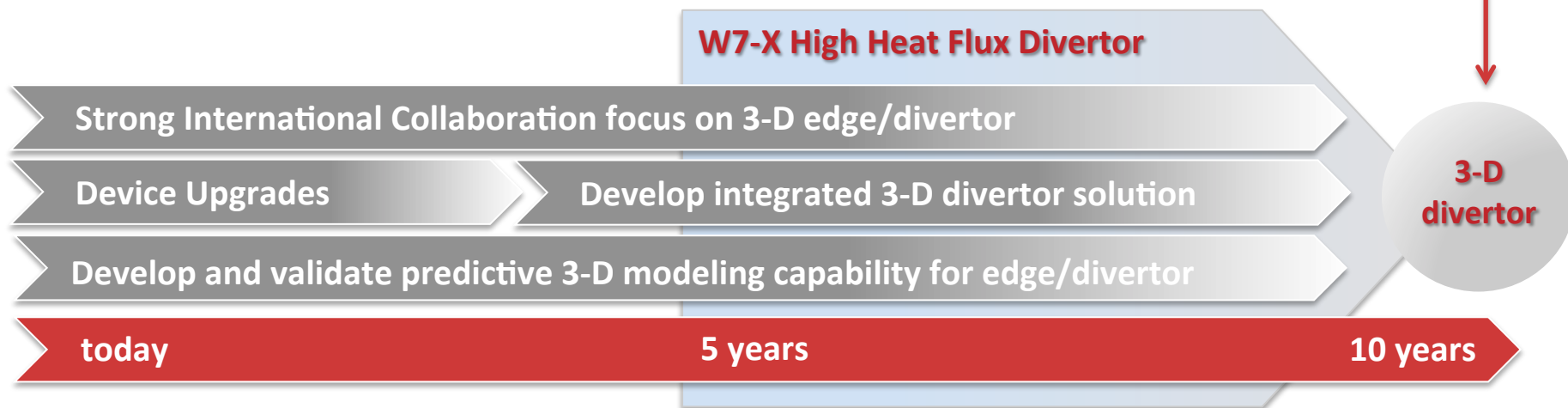



# Initiative I: Enhanced international collaboration to directly link domestic efforts to first steady state stellarator divertor at W7-X

U.S. university workshop for W7-X has lead into a well coordinated participation scheme – one example:

Bootstrap current build up significantly alters divertor structure

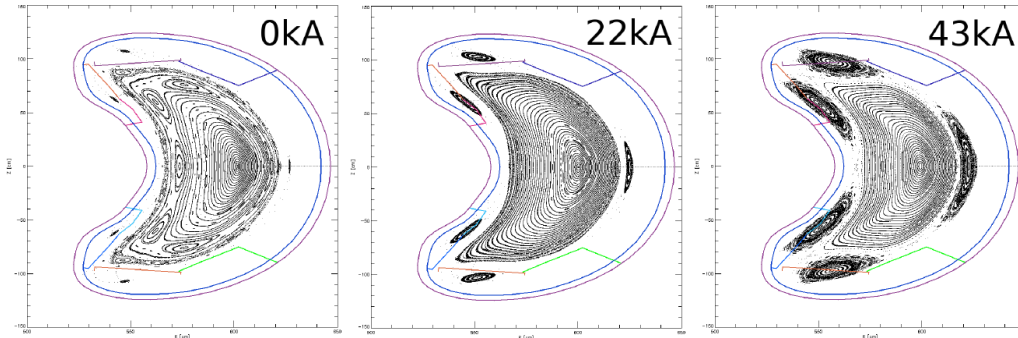

Courtesy of H. Hoelbe (MPG-IPP)

Divertor heat load at critical current level

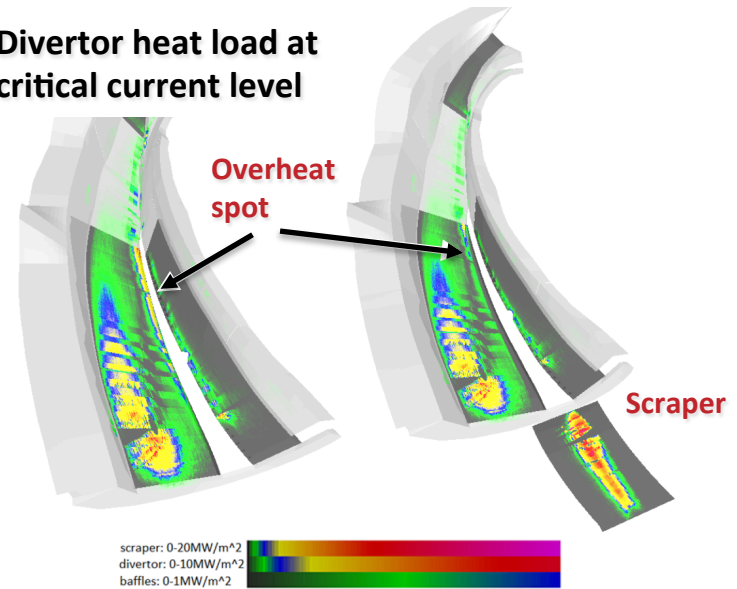

Develop, fabricate and deploy  
scraper element

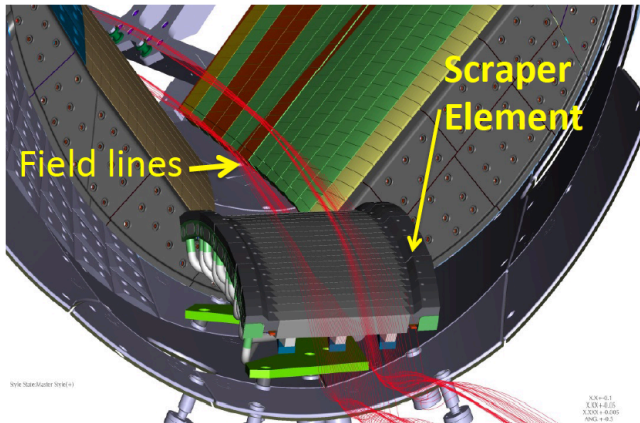

Key investments of initiative

Project employs full suite of U.S. leadership know-how in concert with domestic University experiments

Strong collaboration between national laboratories and Universities

Develop, fabricate and deploy  
versatile scraper observation

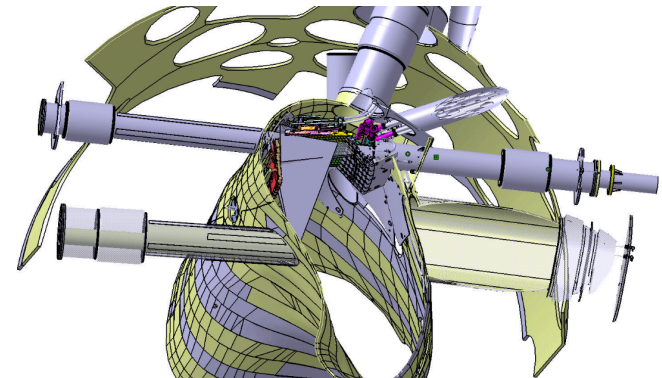

# Initiative II: Near term upgrades of domestic facilities to tackle critical gaps in existing divertor concepts

Goals

Stable divertor topology

3-D optimization

Innovative materials

HSX - Madison

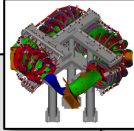

Versatile **3-D divertor test** in integrated fashion with **ion confinement and impurity transport**

**Upgrade strategy**

Increase heating (ion & electron)

Divertor test unit incl. larger vacuum vessel

CTH - Auburn

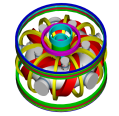

Explore **disruption limits** with 3-D shaping and assess impact on divertor solution

**Upgrade strategy**

Increase VD control and ohmic drive

Implement island divertor

Laboratory Scale Experiments

Develop a **3-D divertor solution**

Education

CNT - New York

Explore long connection length regimes for **heat flux spreading**

**Upgrade strategy**

Enhance heating system (EBW)

Increase power flux density

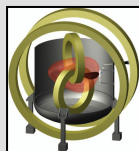

HIDRA - Illinois

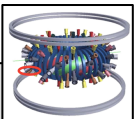

Develop innovative wall and divertor **material concepts** for 3-D systems

**Upgrade strategy**

WEGA stellarator setup and installation

Flexible wall test system and diagnostics

# Initiative III: A coordinated effort to develop and validate a 3-D edge modeling tool with predictive capability

There is practically only one model considered as 3-D edge modeling tool – EMC3-Eirene

## EMC3-Eirene can

Neutral physics	3-D fluid
Volume Sources	Simplified Impurity
Impurity Production	Static magnetic grid
Surface Effects	Transport is input

## EMC3-Eirene can not

Particle drifts	Kinetic effects
Detailed PMI	
MHD	Turbulence

ExB flows measured at HSX

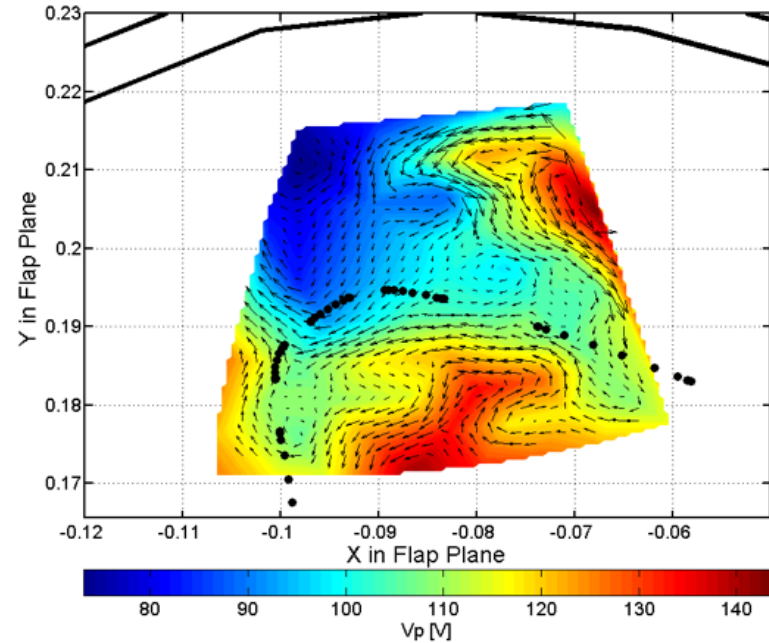

**A 3-D modeling for the plasma edge has to be advanced to generate predictive capability**

**This is an urgent need for analysis of 3-D tokamaks as well (RMP ELM suppression)**

**The development path has to include a thorough validation against experimental data**

**Experiments accessible through these initiatives provide a comprehensive basis for this!**

# The initiatives proposed will put the U.S. stellarator program on the forefront of 3-D divertor research

Initiatives tackle a highly relevant issue for next step stellarator devices

Moderate investment

Low risk

Concrete outcome

Leveraged by past domestic and international investments

Next step device

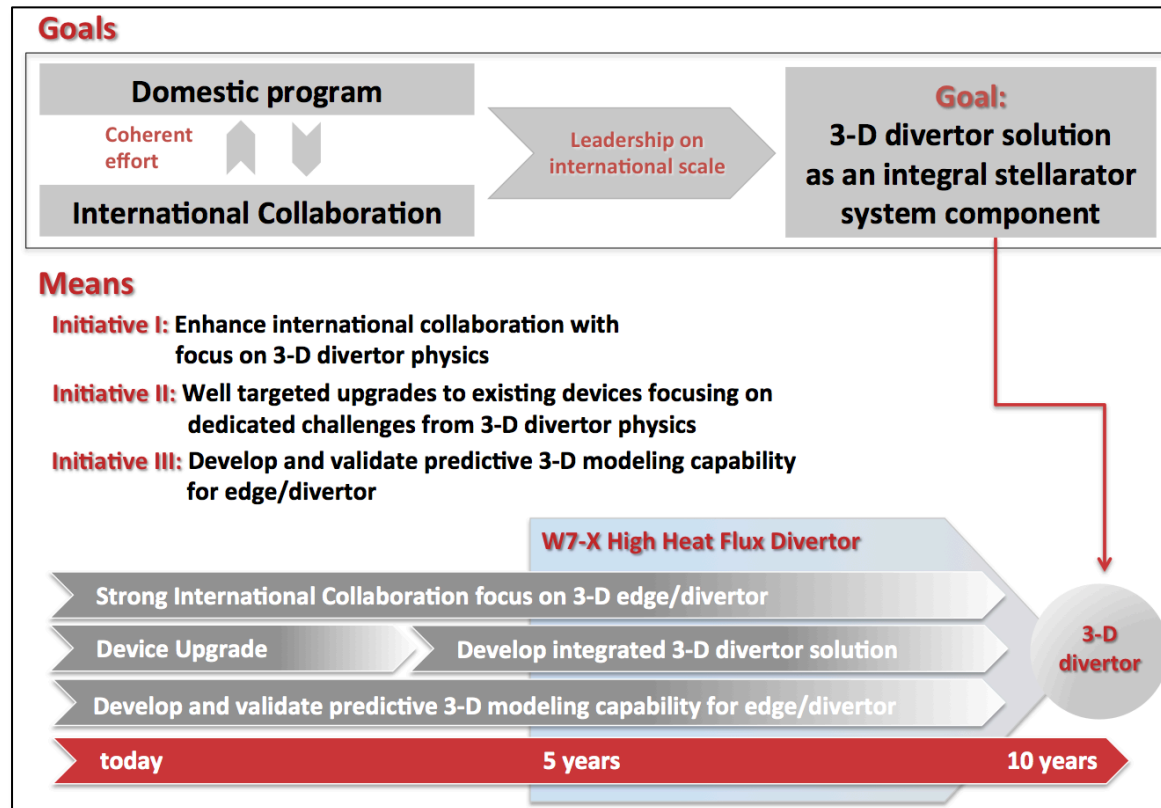

# Appendix

# Emphasis in proposed initiatives is focused on 3-D divertor solution including feedback between the various interface layers

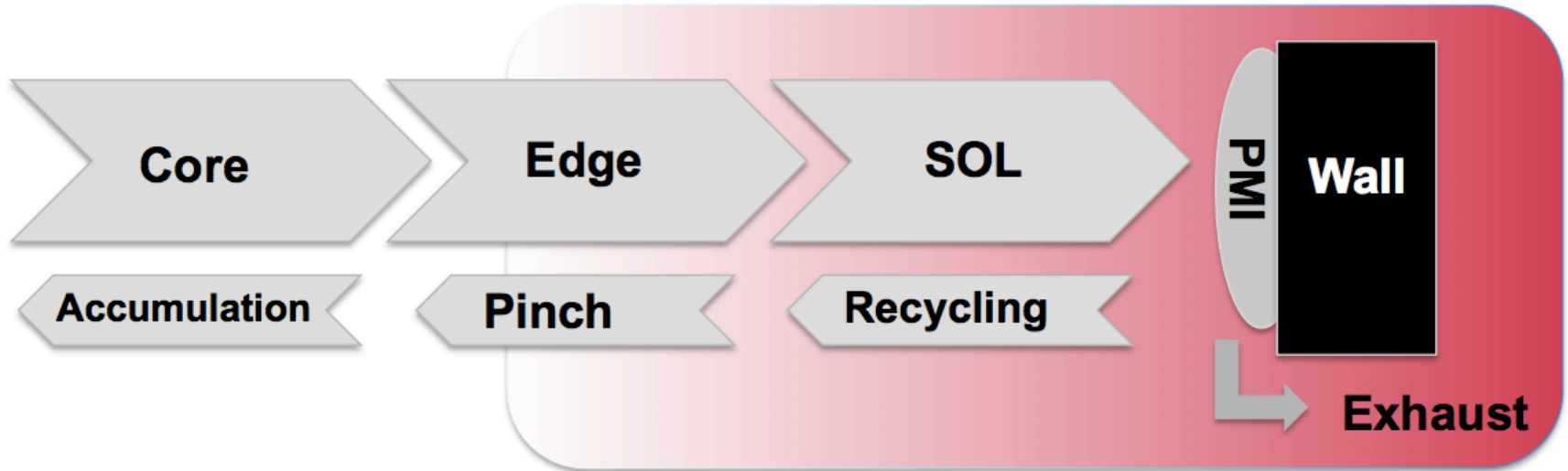

## Critical challenges for a divertor solution:

- Control of neutral density to enable stationary plasma density operation
- Retention of neutrals and impurities in divertor chamber
- Particle exhaust requirement results in demand for high heat flux handling
- Sustainable material choice is must be compatible with exhaust requirements and low impurity source levels
- Remaining re-fueling of plasma with neutrals and impurities has to be low
- Off-normal events have to be passively avoided in optimal solution
- **Key operational goal: Achieve high density, cold divertor with stable wall conditions**



# US has near-term opportunities to excel in long-pulse physics through prioritized incremental funding

Present US stellarator funding ~\$5-6M/year, but could rapidly expand in steps:

1. Increased support for 3D theory/computation is the first priority and an essential part of all these activities. [**Increment \$3-4M/yr**] *Talk M. Landreman*
2. Expand US partnership on W7-X, including national laboratories, universities and private companies. Present funding for W7-X: \$2.5M/yr (labs). Immediate expansion to **\$5M/yr and then to \$10-12M/yr** over next 5 years would allow US to increase involvement in divertor and core physics, deploy steady-state pellet fueling (ITER prototype) and take advantage of long-pulse capabilities. *Talk G. Wurden*
3. Upgrade existing and add new facilities to explore 3-D divertor physics that scale to reactors. HSX: Ion heating, higher density, flexible divertor configuration; CTH: Increased ohmic heating for disruption studies and explore edge physics; HIDRA(WEGA): PMI studies in a stellarator environment. [**Increment \$7-8M/yr**] *Talk O. Schmitz*
4. Mid-size US stellarator experiment. Fastest implementation (QUASAR, **\$130M construction over 5 yrs, ~\$60M/yr operation**) could use NCSX design and coils. *Next slides.*
5. Develop design options and mission-need for next-step U.S. stellarator facility. Possible missions range from a DD JET-scale device to an FNSF. (**≥ 5 years, ~\$5M/yr**) *Talk M. Zarnstorff.*



# HSX-Upgrade: Budget requirements and profile

- Major element cost breakdown (over 4 year period) (\$k)
  - 2 X 300kW 0.3s Beams (w/PS-torus interface) 2400
  - 500 kW 0.3s ECH (w/PS, transmission line, launcher) 1300
  - Vacuum vessel/ divertor chamber/structure 2800
  - New coil-type #1's 1100
  - Infrastructure and contract engineering 2400
  - Contingency (@20%) 2000
  - Total cost 12000**
- Site credits reduce cost of upgrade
  - Only 16% of coils remanufactured/ majority support and infrastructure (DAQ/Control, etc) used
  - Existing 54 MJ motor/generator supply for magnets
  - Utilize existing diagnostics (Thom. Scat., ECE, CXRL, reflectometry, spectroscopy, +)

Year	1	2	3	4	5
Construction	1.5	4.0	4.5	2.0	0.0
Operations	1.6	2.0	2.5	4.0	4.0
Total	3.1	6.0	7.0	6.0	4.0

**Highly increased capabilities/mission for HSX with a total increment of \$15.6M over 4 years**

# CTH-Upgrade: Budget requirements and profile

- Major element cost breakdown (over 3 year period) (\$k)
  - 200 kW, 28GHz ECRH (w/PS, transmission line, launcher) 1000
  - 300kW Beam (w/PS-torus interface) 1200
  - Vertical/Ohmic PS upgrade for tokamak operation 750
  - Vacuum vessel/ divertor chamber/structure 100
  - Diagnostic suite upgrades (island/disruption studies) 500
  - Infrastructure and contract engineering 250
  - Contingency (@20%) 760
  - Total cost 4560**
- Site credits reduce cost of upgrade
  - Infrastructure (DAQ/Control, etc) used
  - Existing motor/generator supply for magnets and capacitor banks used

Year	1	2	3	4	5
Construction	0.5	1.5	1.5	1.06	0.0
Operations	0.75	1.0	1.25	1.25	1.25
Total	1.25	2.5	2.75	2.31	1.25

**Highly increased capabilities/mission for CTH with a total increment of \$6.8M over 4 years**

# CNT Budget requirements

- Major upfront costs (\$k)
  - Transmission line and antenna for *existing* 4 MW, 1-3 MHz, 10 ms source 150
  - Transm.line, antenna, PS and infrastructure for klystron to be borrowed 250

**Total cost 400**
- Existing MW-level flywheel generator, capacitor-banks, RF PSs and triodes will reduce cost of upgrade.
- Construction (mostly diagnostics: microwave, X-ray, optical spectroscopy...) and operation will cost, including overhead:

Year	1	2	3	4	5
Staff (1 post-doc, 2 students)	260k	270k	280k	290k	300k
Equipment, consumables, travel, publications	140k	130k	120k	110k	100k
Total	400k	400k	400k	400k	400k

**Completing conversion and operating formerly non-neutral CNT as a device for fusion-relevant studies should cost \$2.4M over 5 years.**

# Upgrade of HSX for exploration of integrated concept

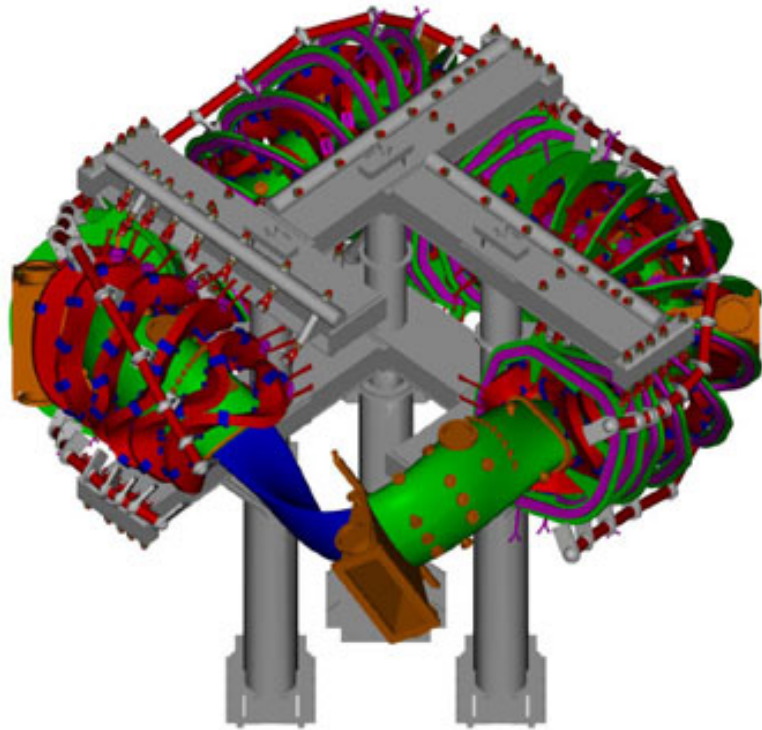

Helical symmetric experiment has demonstrated good neoclassical confinement – this is an ideal basis

## Goal:

Qualify innovative 3-D divertor topologies within integral, optimized stellarator towards key aspects:

- Innovative 3-D divertor topologies
- NBI deposition in a high effective shear stellarator
- Low collisionality ions and ion root electric field
- Configurations for reduced turbulent transport

## Means 1: Ion heating

- Implement two neutral beams (2x300kW a 0.3s)

Ion heating for access to higher density with significant ion temperature to obtain a transport dominated plasma opaque to neutrals

Low collisionality ion transport and impurity transport

## Means 2: Enhance electron heating

- Replace gyrotron with 56GHz, 2<sup>nd</sup> harmonic heating

Access heating of plasma densities in the  $2.0 \times 10^{19} \text{ m}^{-3}$  range to provide a target for NBI heating and densities up to  $10^{20} \text{ m}^{-3}$  range

Upgrade will assure a reliable working baseline heating system

Upgrade on heating systems is a prerequisite for divertor studies

At the same time, low collisionality ion physics and ion root impurity transport becomes accessible

# HSX is a perfect test bed for topological optimization of a 3-D divertor solution

HSX features high flexibility in edge magnetic topology

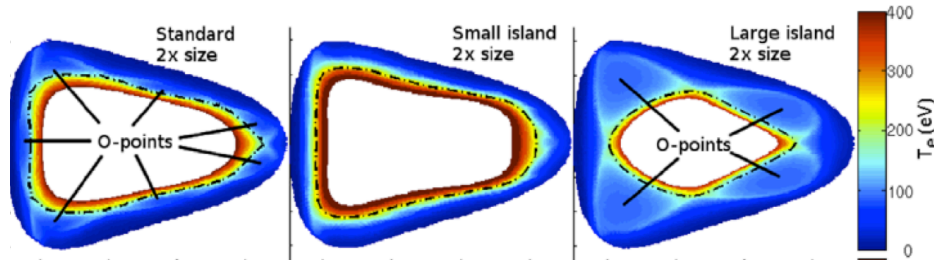

Separation of plasma and divertor is key  
**HSX design enables coil extension maintaining overall equilibrium to make room for divertor**

Concept for extension of coil 1 and impact on flux surfaces

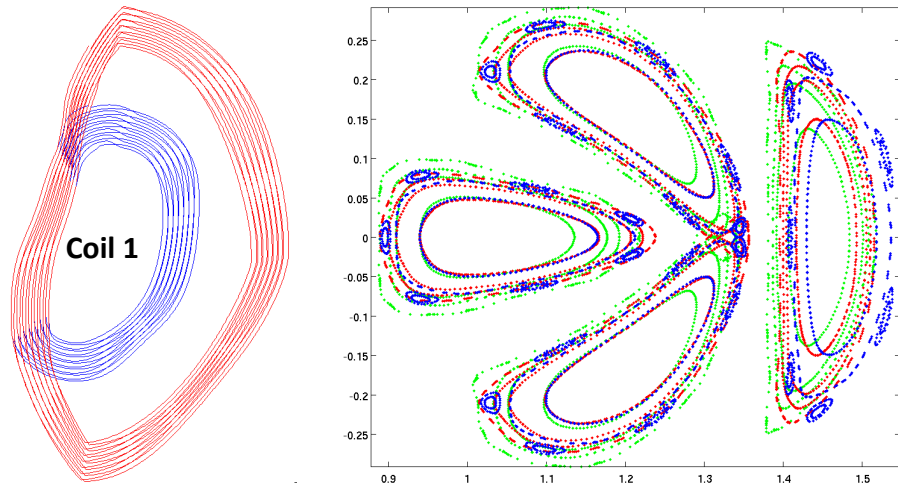

**A total of 8/48 coils have to be redesigned & fabricated**

## Means 3: 3-D divertor test unit

- Redesign coil 1
- New vacuum vessel to exploit full room within existing coils

One out of six coils have to be redesigned

New coil 1 design allows large freedom for actual shape of 3-D divertor leg

New vacuum vessel to increase distance to wall

**High access divertor chamber to permit flexibility in divertor configurations and materials**

**Materials Science Center offers access to state of the art surface and material analysis**

## Time line for HSX-Upgrade

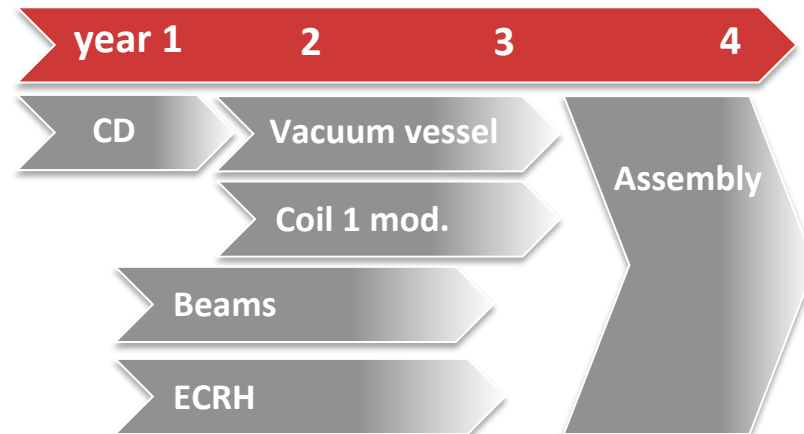

# HSX Upgrade: Physics goals and hardware requirements

- **Increased ion temperature (through NBI) to:**
  - Study role of high-effective transform ( $\nu_{\text{eff}} \sim 3$ ) on NBI deposition in a high electron temperature plasma
  - Understand effect of electric field on impurity transport in reactor-relevant ion root
  - Study low-collisionality ion transport (previous HSX studies at low  $\nu_e^*$ )
- **Higher density operation for:**
  - Increase divertor plasma parameters and compare to model calculations
  - Study impurity transport and potential for accumulation
  - Reduce charge exchange losses and increase operational flexibility
- **Upgrades to achieve:**
  - New vacuum vessel and type #1 coils for NBI and diagnostic access, improved conditioning, larger plasma/wall separation, more room for flexible divertor configurations
  - ECH: 500 kW, 0.3 s, 56 GHz; energetic electron transport and beam target
  - NBI: 2 X 300 kW 40 keV 0.3s systems (Budker Inst./ Compass D units)
  - Infrastructure upgrades to accommodate new capabilities



# Enhance CTH for qualification of 3D shaping for disruption avoidance including divertor

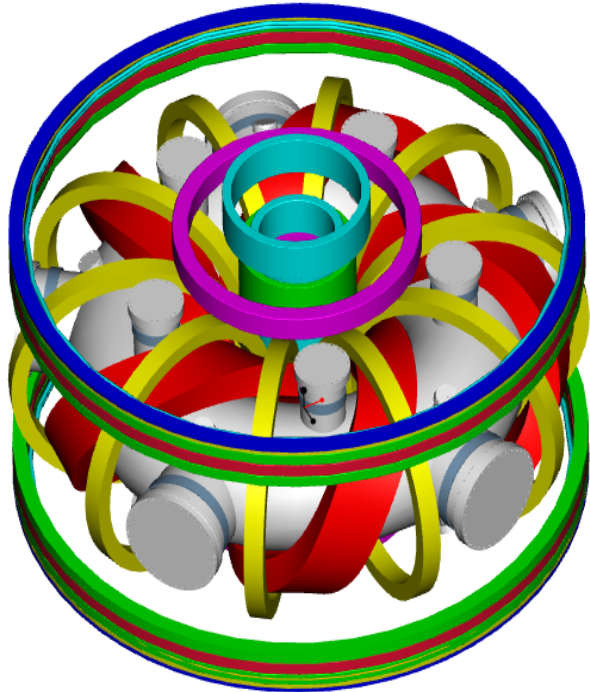

Compact Toroidal Hybrid addresses 3-D shaping as means for disruption avoidance

## Goal:

Test 3-D shaping benefit in integral fashion with island divertor

## Means 1: Qualify benefit of 3-D shaping

Enhancement of ohmic drive increases this capability

Increased heating for exploration of 3-D shaping on disruption (density) limits

## Means 2: Implement island divertor

Assess impact of specific 3-D shape on divertor solution

Magnetic control coils enable fine tuning of island and optimize stability and divertor performance

Study magnetic control field penetration into 2-D and 3-D plasma equilibria

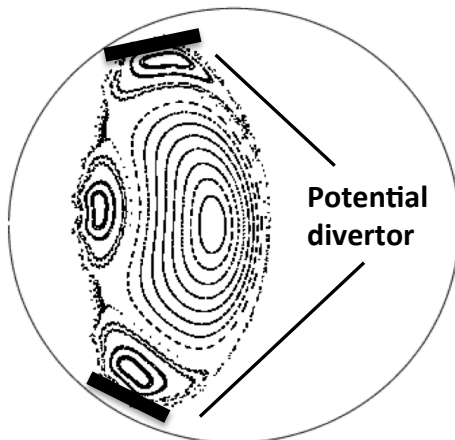



# CTH Upgrade: Physics goals and hardware requirements

- **High SOL power flux with ECRH for stellarator plasmas**
  - Study high temperature/power edge island divertor physics
- **Tokamak operation allows new disruption physics studies:**
  - Well-known disruption phenomenology, then add rot. transform
  - Allows comparison/understanding of disruption quench/loss of confinement dynamics with and w/o transform (cage effect)
  - Explores  $B_{3D}/B_0$  down to similar levels used to optimize current tokamaks
- **Auxiliary heating using NBI to:**
  - Explore density limit physics using auxiliary heating with rot. transform
  - Decouple tokamak (Greenwald) and stellarator (Sudo) density limits
  - Understand transition from tokamak to stellarator-like limit
- **Upgrades to achieve:**
  - ECH: 200 kW, 28 GHz; high power divertor and ohmic target
  - Vertical/ohmic PS upgrades to allow tokamak operation/control
  - NBI: 300 kW 40 keV 0.3s systems (Budkar Inst./ Compass D units)
  - Infrastructure upgrades to accommodate new capabilities

# Build up HIDRA as development facility for innovative 3-D wall and divertor materials concept

HIDRA is based in existing stellarator device WEGA and hence a very realistic approach

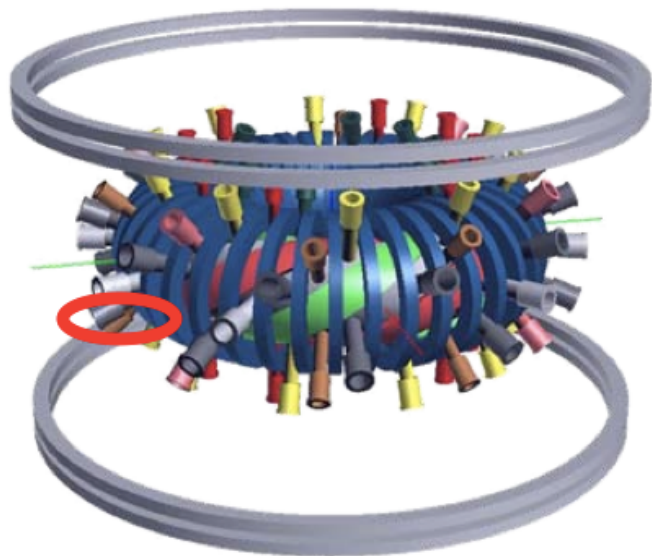

Courtesy of WEGA team



## Goal:

Develop innovative wall and divertor concepts in 3-D environments and provide for wall/materials and plasma edge physics code validation

**Means 1:** Install and start-up device at U Illinois  
Restore capabilities and setup infrastructure  
Equip with suited diagnostics for computational code validation

**Means 2:** Realize technical setup for wall testing

Targets on exposure of metal wall elements  
Exploration of new wall concepts (e.g. liquids)  
Qualification of Lithium wall components  
(hierarchical systems and liquid materials)

**Means 3:** Educational platform for student training

Provide for student/postdoc training and pipeline to large fusion devices and facilities (e.g. international collaboration with W7-X IPP Greifswald)

# **Five main thrusts are the vision for HIDRA device (WEGA stellarator)**

- **Develop as toroidal PFC test facility aimed at liquid metals and enabling technology development.**

The ability to run as a tokamak as well as a stellarator will allow to provide a test bed for fully axisymmetric PFC experiments. This will cover approaches to create workable divertors for the Stellarator community as well as tests for high-powered liquid metal solutions.

- **Education device for undergraduate and graduate students**
- **Materials synthesis facility**  
Plasma exposure can create a number of technologically interesting nano materials for use outside of the fusion community.
- **Test bed for model validation with specific emphasis on electron transport theories**
- **Platform for diagnostic development**
- **Estimated annual budget: 300 k\$**

**Program is forming but is uniquely emphasizing materials  
synthesis and liquid metal PFC**

# CNT has a large vessel and long connection length



Columbia Non-neutral Torus (CNT) is now a Neutral stellarator, microwave-heated

## Goal:

Insert movable island divertor, image wetted area and study dependence on magnetic configuration.

**Means 1:** Use access to test/optimize different island divertors, move them relative to plasma and diagnose by Langmuir probes and IR imaging.

- Heating power being increased → increased heat load on divertor, good diagnostic access.
- Long pulses (several seconds).

**Means 2:** Confirm and characterize more benign wetted area scaling in stellarators.

- Wetted area scales unfavorably (too narrow) with large  $B_p$  in tokamaks [T. Eich, *PRL* 2011].
- Expected to broaden in low-shear stellarators thanks to low  $\iota$  inside island [T. Pedersen].





# Initiative I: Scraper element within an expanded joint U.S. University and National Laboratory program on 3-D divertor physics at W7-X

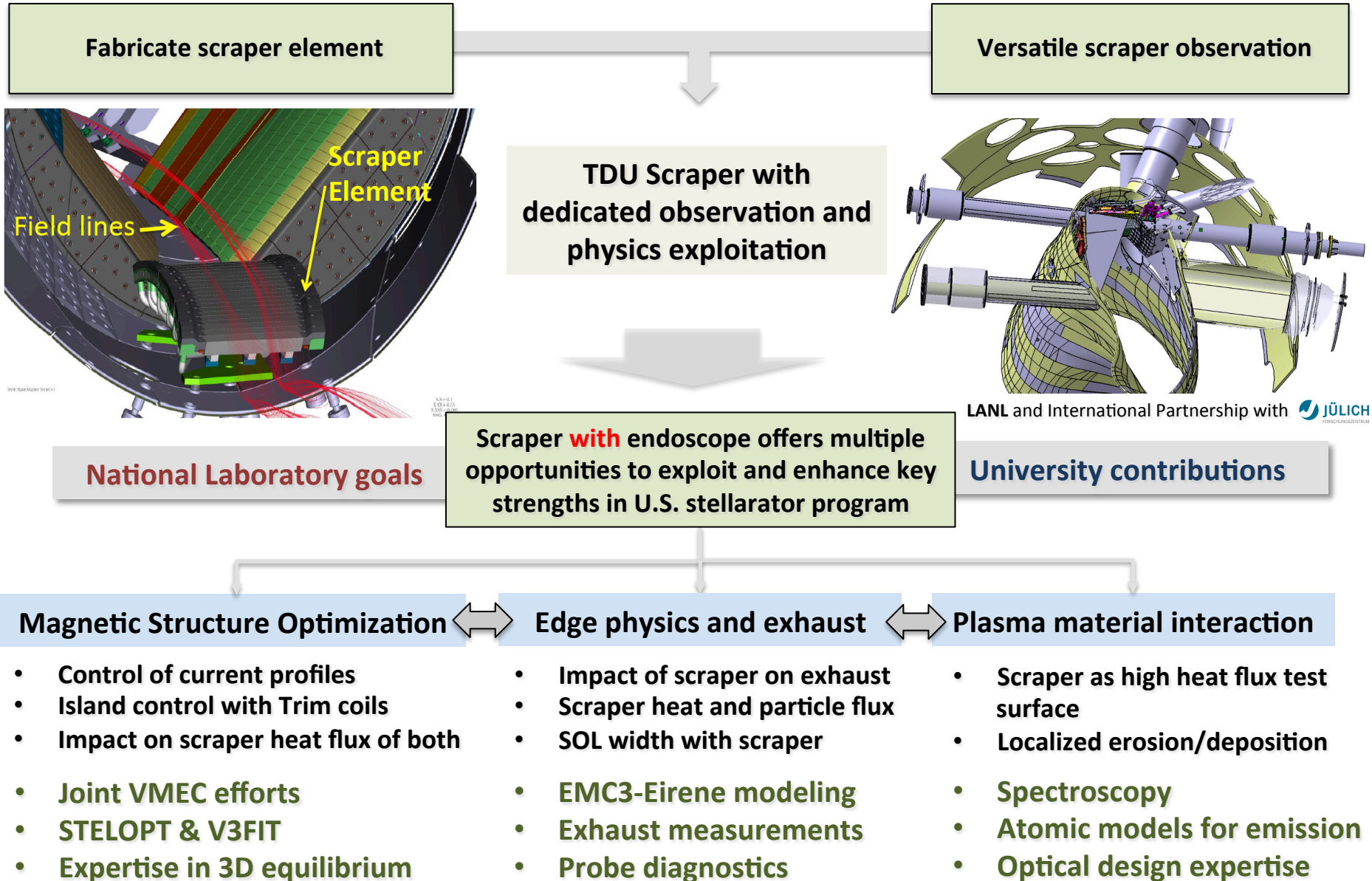

# Supporting laboratory scale experiments can address basic questions of key relevance for success of overall effort

Atomic spectroscopy is of generic importance for analysis of plasma edge physics and plasma wall interaction – **Helium line ratio spectroscopy** as an example

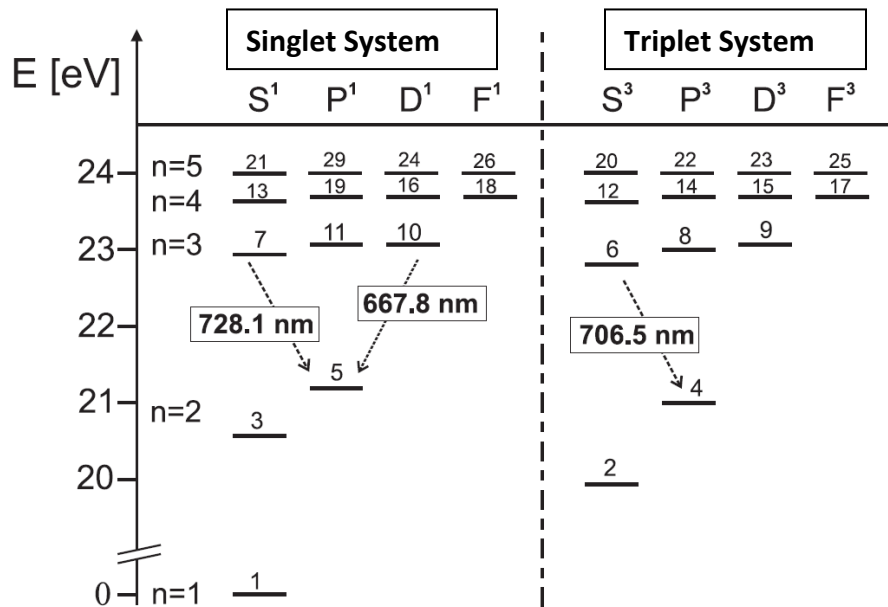

O. Schmitz et al. PPCF **50** (2008) 115004

## • Suitable transitions:

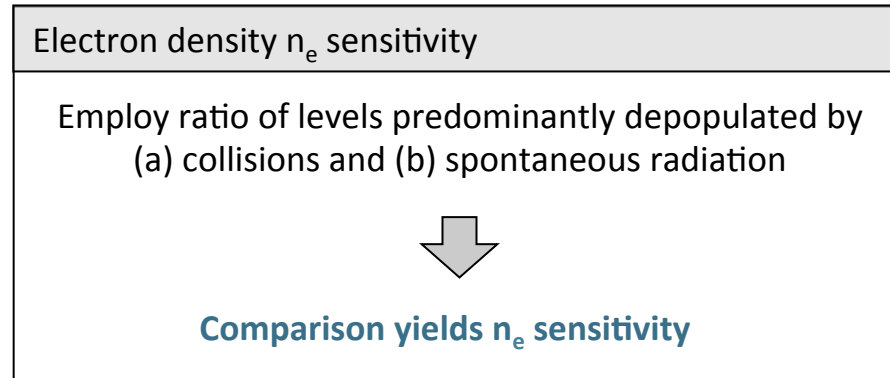
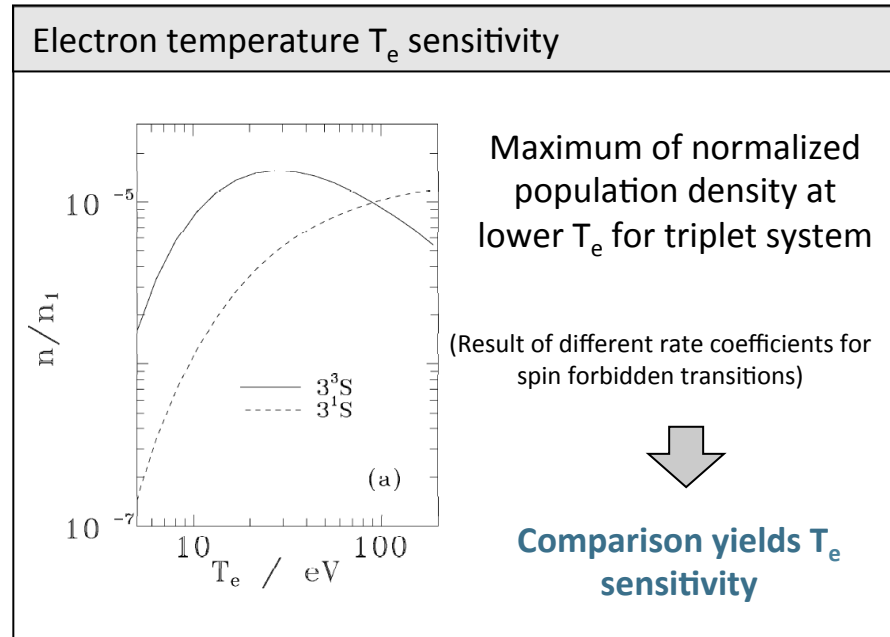

# Reliable application as edge diagnostic shown at TEXTOR

A dedicated atomic physics test stand is an important supplemental activity

Stationary solution shows typical application range

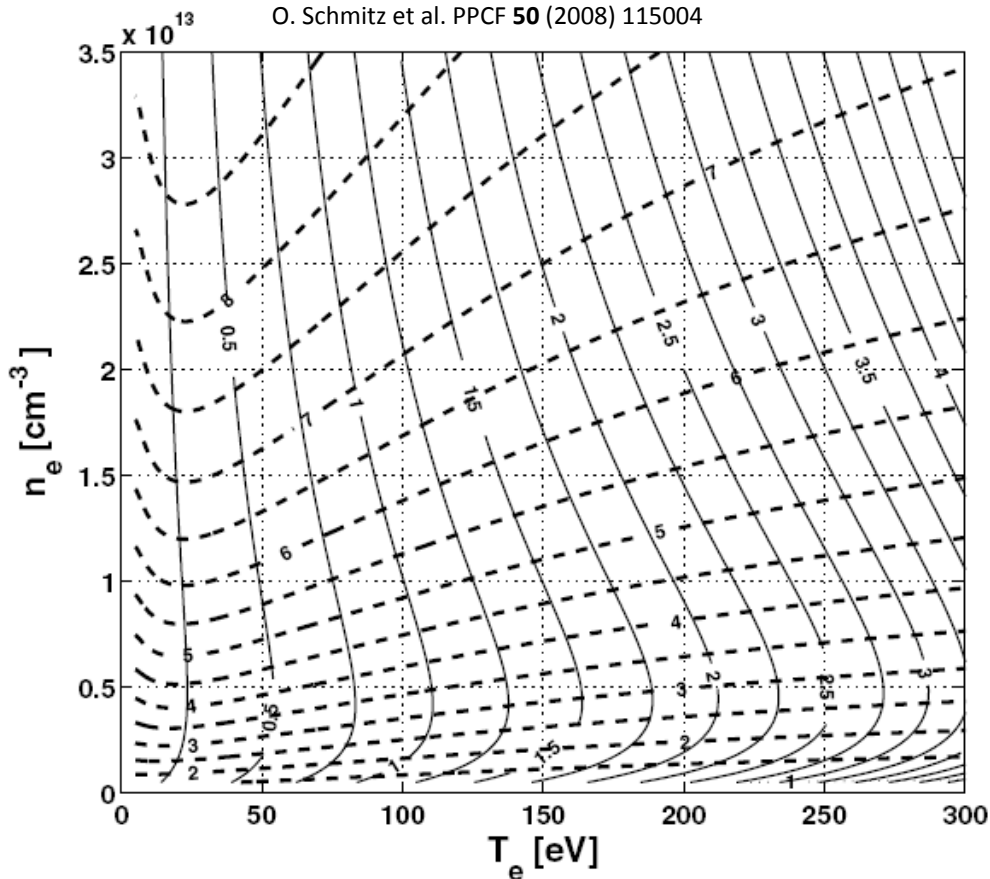



# High density, low temperature environment is new territory

A dedicated atomic physics test stand is an important supplemental activity

**Extension required for anticipated divertor plasma regime at Wendelstein 7-X**

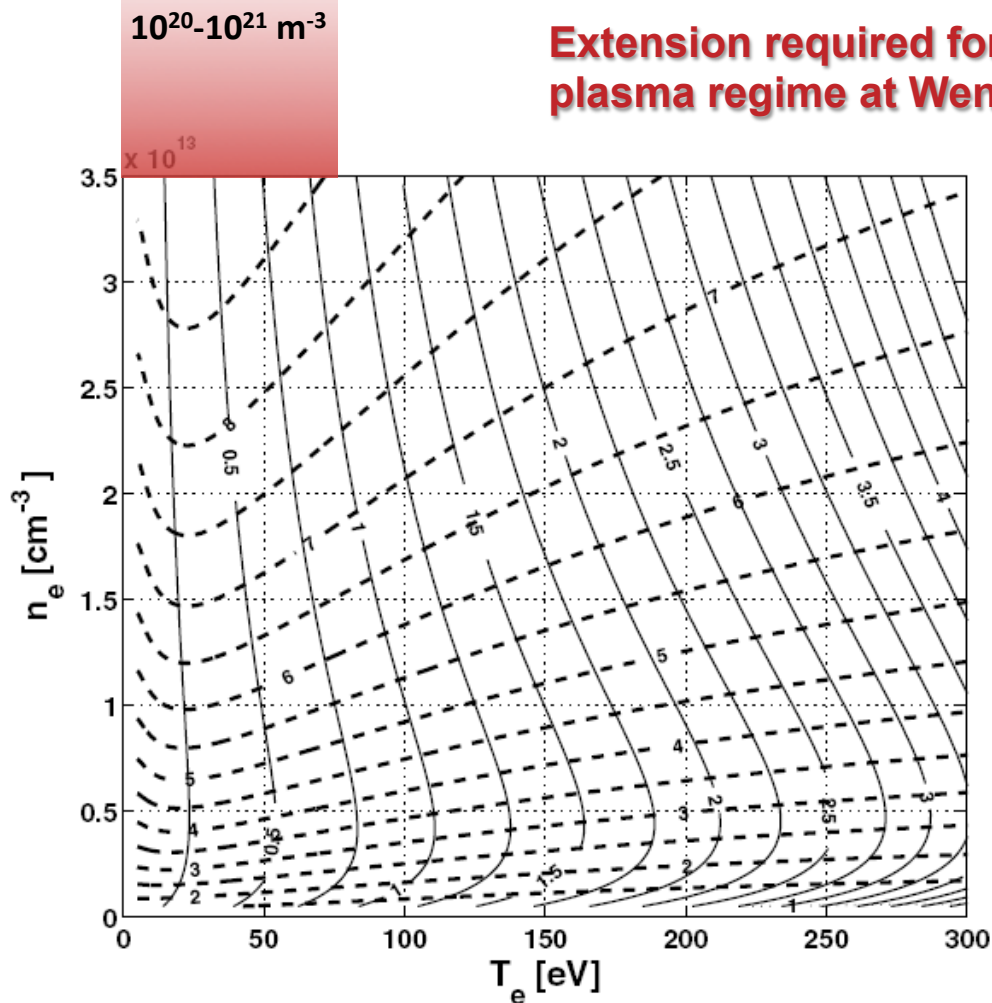

# High density, low temperature environment is new territory

A dedicated atomic physics test stand is an important supplemental activity

## Extension required

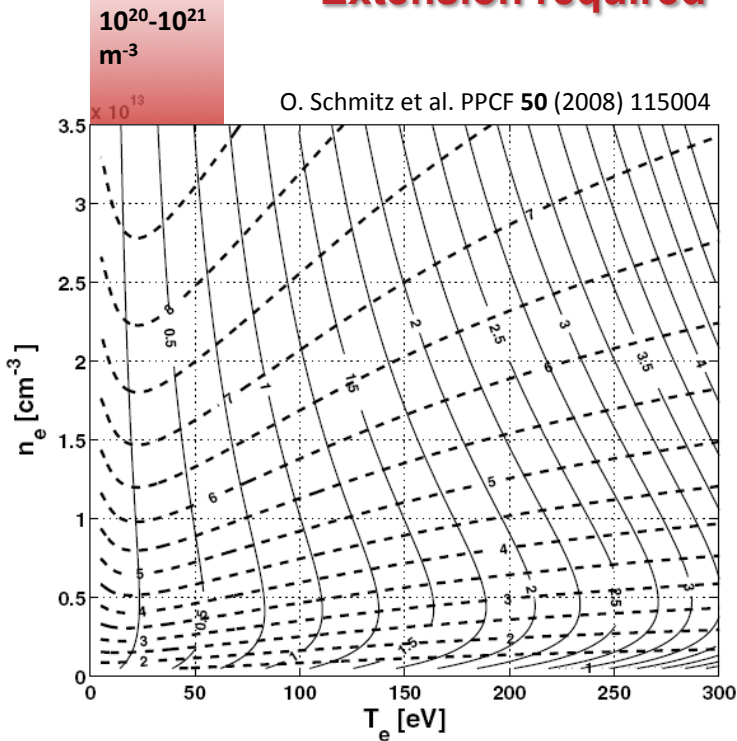

## Helicon plasma test stand is available and we target on dedicated upgrade

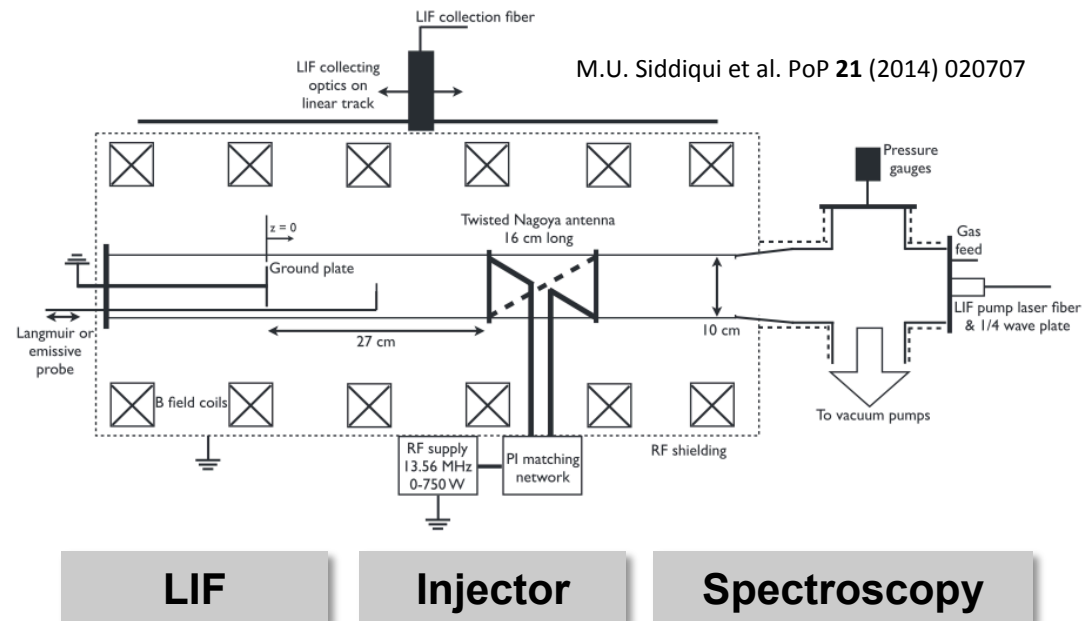

## Goals of development and validation efforts

- Improve atomic data by direct measurement with LIF
- Expand model for He and Ne towards densities of  $10^{21} m^{-3}$
- Implement in EMC3-Eirene and develop unified analysis suite

## Costs:

- Setup ~ 0.8 M \$
- Annual ~ 0.3 M \$

# EMC3-Eirene is the work horse for 3D edge transport modeling

Application to 3D edge layers in stellarators and heliotrons to tokamaks impacted by resonant magnetic perturbation fields

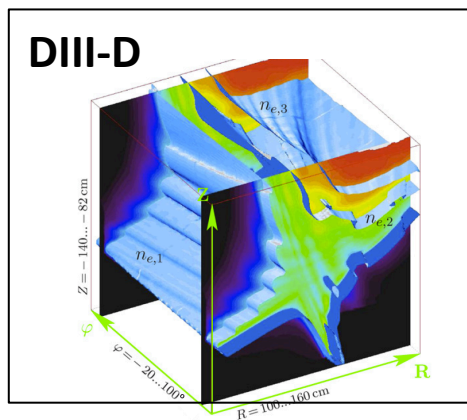
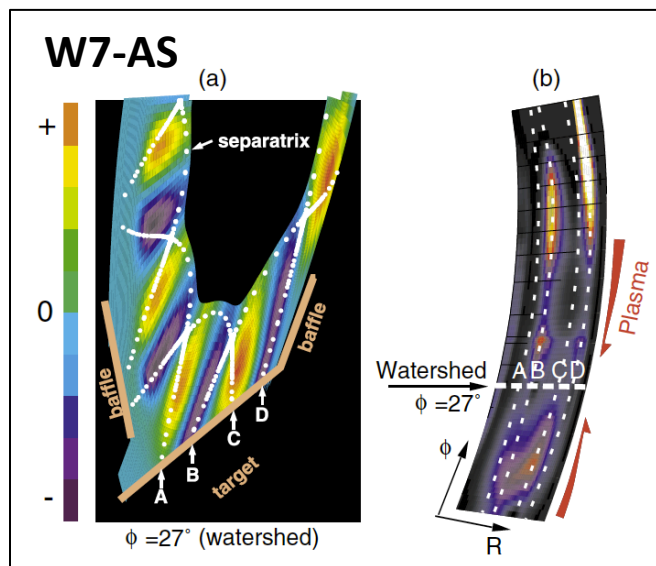
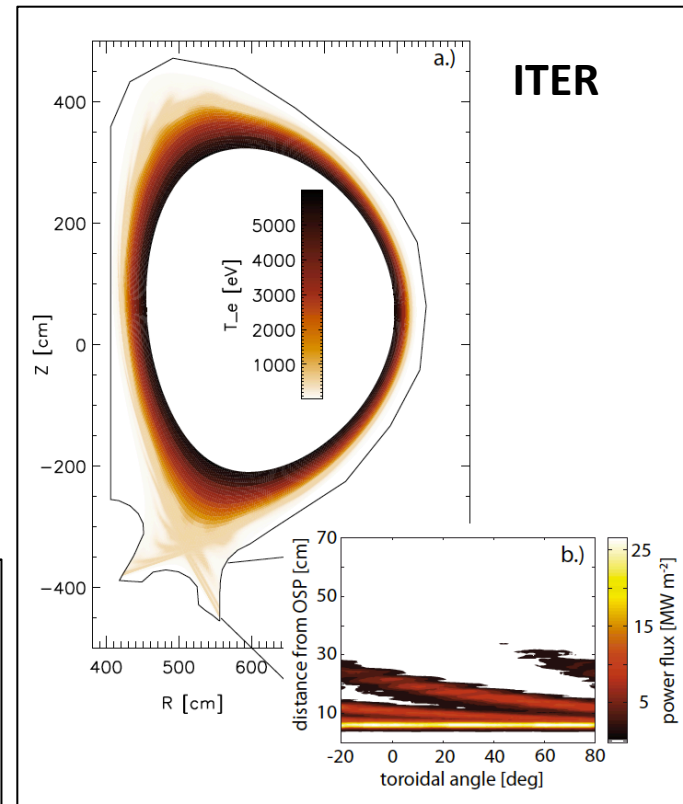
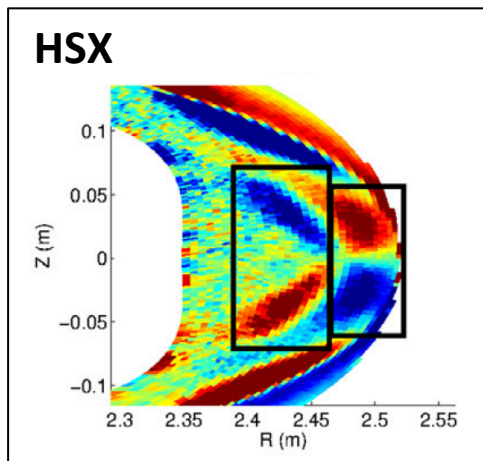
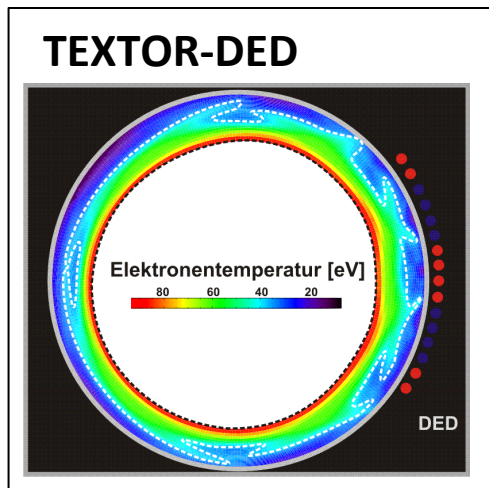

... and more  
(LHD, AU, Tore Supra, TCV...)

We are strongly involved in development and exploitation of EMC3-Eirene

# Coordinated device upgrades will give enhanced access to high quality validation scenarios and data

Significant deviations between model and measurement stimulate exploration of requirements for model enhancement

Measurement

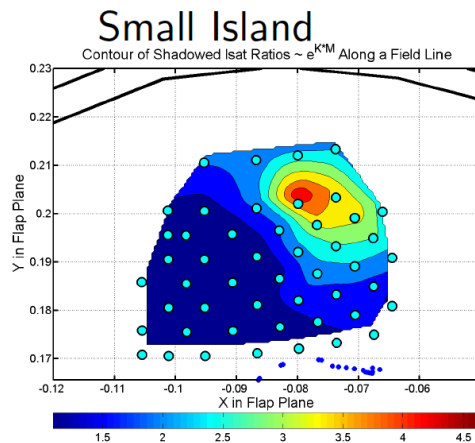
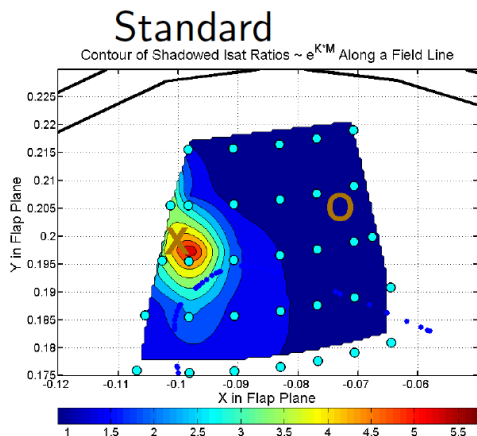

EMC3-Eirene

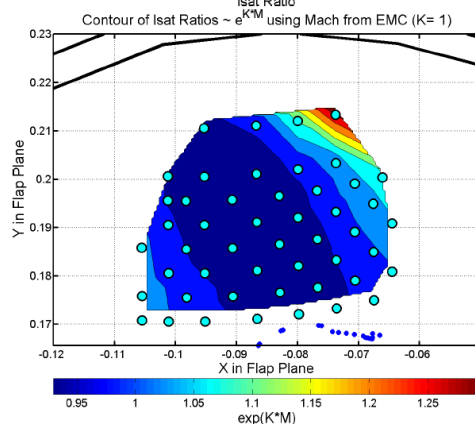
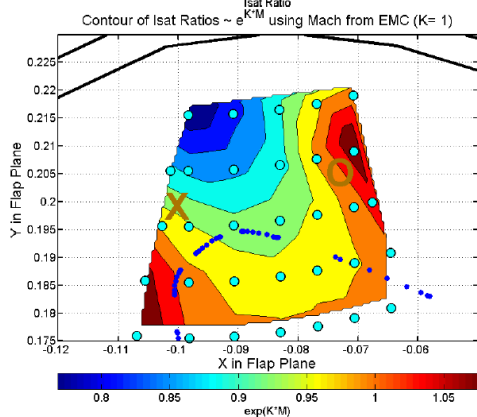

Candidates for validation and enhancement (examples)

- Neutral boundary condition
- Neutral exhaust
- Plasma potential
- Drift effects
- Correction of kinetics effects
- Impurity transport

**3-D divertor program requires a reliable numerical tool for interpretation and extrapolation**